

Quick-Step® multifunctional profile

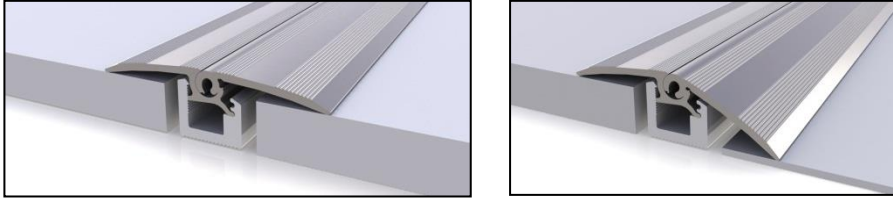

Product specifications

Quick-Step® multifunctional profile QSPRSILV

Silver colour

Dimensions 1 PC: 16x47x1860 mm (max. dimensions fitted)

Order quantity: per 1 PC in shrink-wrapping

Product description

The Quick-Step® multifunctional profile provides a simple solution for the perfect finish to different types of floors. You can bridge heights of 0 to 12.3 mm with just one profile. You can use it as an expansion profile or an adjustment profile.

The profile is made of scratch-resistant aluminium in silver colour.

Preparation

The Quick-Step® multifunctional profile is easy to fit.

Use gloves, because some parts of the profile might be sharp.

First, saw the aluminium profile and the plastic rail to the right length.

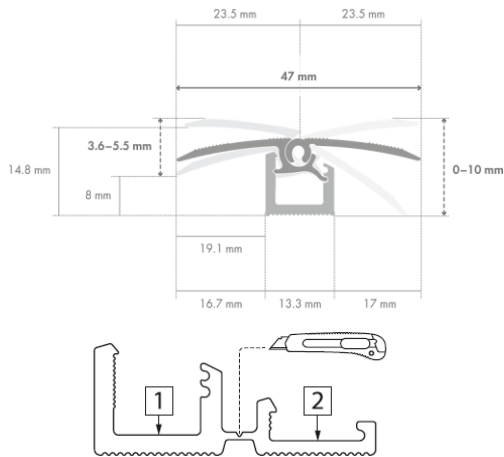

The **aluminium** profile consists of two parts, which you can separate along the break line. Hold the profile firmly in both hands and start by prying one side up and down. Do this step by step over the entire length of the profile until both parts have completely separated.

The **plastic rail** also consists of two parts. Separate them by cutting the notch with a Stanley knife.

For differences in height of up to 5.5 mm, you use the lower rail; for differences in height between 5.5 and 12.3 mm, use the higher.

Installation

1. Expansion profile

You can use the multifunctional profile as a smooth transition between two floors of equal height:

- e.g. in a doorway.
- or, in a large room (> 12 m laminate or Livyn in one piece) where the floor must be able to expand.

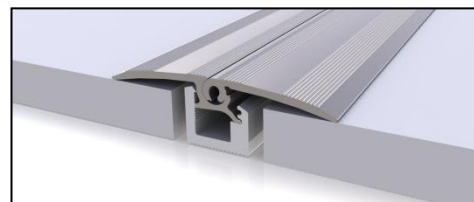

Room humidity and temperature can vary from season to season, so it is vital that the floor is able to expand and contract. The floor must be able to expand and contract on all sides. This profile ensures that the floor can always move freely.

Installation of the rail

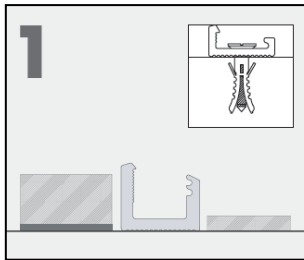

Fix the rail to the underfloor with screws. Screw them into the pre-drilled holes in the rail. Use 3x30 mm screws.

Fit it directly to the underfloor between the two floors. Leave enough space between the rail and the two floors; observe the recommended expansion joint per type of floor.

You can also glue the rail to the underfloor with Quick-Step® One4All Glue.

IMPORTANT! Press firmly to ensure it is attached flat to the underfloor. Allow sufficient drying time (24 hrs) before you fit the rest of the profile.

Installation of the aluminium profile

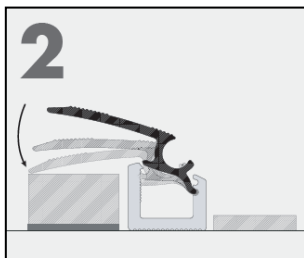

Now place the bottom part of the aluminium profile in the rail. When you do this, the wing of the profile sits on the higher side of the rail.

Press the profile from one side to the other in the rail. Press until it is against the floor.

Use the higher rail for differences in height between 5.5 and 12.3 mm, and the lower one for differences of less than 5.5 mm.

Low rail: < 5.5 mm

High rail: 5.5 - 12.3 mm

Make sure everything is free of dust and aluminium particles. Place the top part of the aluminium profile vertically in the bottom part and rotate it downwards until it touches the floor.

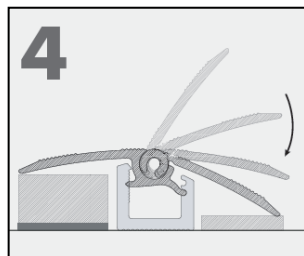
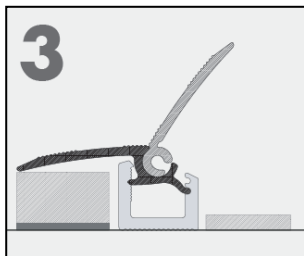

2. Adapter profile

You can also use the multifunctional profile as an adapter profile, to bridge differences in height between two floors cleanly:



- E.g. between a Quick-Step® laminate and a Quick-Step® Livyn floor
- between Quick-Step® laminate or Livyn and another lower floor
- or between floors with differences in height up to 12.3 mm.

Follow the same installation steps as explained above for this.

IMPORTANT!: In this case, do make sure that the higher vertical side of the rail is on the side of the higher floor.

Use the higher rail for differences in height between 5.5 and 12.3 mm, and the lower one for differences of less than 5.5 mm.

All the benefits at a glance

- One profile for different applications
- Can be used for Quick-Step® laminate *and* Livyn, or other floors with differences in height up to 12.3 mm.
- A quality Quick-Step® finish for your floor in scratch-resistant aluminium.

Difference in height (incl. underfloor)	Height of installed profile	Expansion profile	Adapter profile
10 mm up to 12.3 mm	between 5.5 mm (with a 10 mm height difference) and 3.6 mm (with a 12.3 mm height difference)		
8.1 mm up to 10 mm	between 5.5 mm (with a 8.1 mm height difference) and 3.6 mm (with a 10 mm height difference)		
3.6 mm to 5.8 mm	between 5.5 mm (with a 3.6 mm height difference) and 3.6 mm (with a 5.8 mm height difference)		

